

Description

The C365 thermostat controls the heating and cooling system the same as most programmable thermostats. It also controls the airflow to the upstairs and downstairs using an upstairs and a downstairs modulating damper. A temperature sensor located upstairs monitors the upstairs temperature and the temperature sensor in the C365 monitors the downstairs temperature.

The C365 adjusts the upstairs and downstairs airflow during heating and cooling calls to maintain uniform upstairs and downstairs temperatures.

System Modes

Off, Heating only, Cooling only, Automatic Heating or Cooling.

Fan Modes

Continuous or Automatic fan operation.

Thermostat Modes

Hold, Schedule or Vacant mode.

Programs per Day

Morning, Daytime, Evening and Night.

Program Format

Weekdays and weekend— 5/2.

Temperature Override

Up/down keys adjust the setpoint temperature. Temperature setting is held for 4 hours when adjusted in Schedule mode.

Airflow Modes

Automatic or Manual when Manual mode is enabled.

Airflow Override

Up/down keys adjust the upstairs/downstairs airflow. Airflow setting is held for 4 hours when adjusted in Automatic mode.

Airflow Limits

Maximum upstairs and downstairs, heating and cooling airflow limits are set during installation.

Nighttime Operation

Option used when bedrooms are located upstairs. C365 uses the upstairs temperature sensor to control heating and cooling calls and directs more airflow upstairs.

Compatible HVAC Equipment

Single stage gas or electric heating with single stage compressor.

Upstairs Temperature Sensor

One Model TS5-10 or two Model TS5-20 upstairs temperature sensors can be used.

Modulating Dampers

Round or rectangular dampers using the A80MT actuator and up to 1 inch static pressure.

Power

Operates on 24VAC from the HVAC equipment using the R and C wires.

Warranty

This thermostat is warranted to be free of defects due to workmanship or materials under normal use and service for a period of 5 years from date of installation and not longer than 6 years from manufacturing date code.

SEPARATE THE C365 SUBBASE

Place a slotted screwdriver in the slots as shown and rotate to remove subbase from the C365 housing.

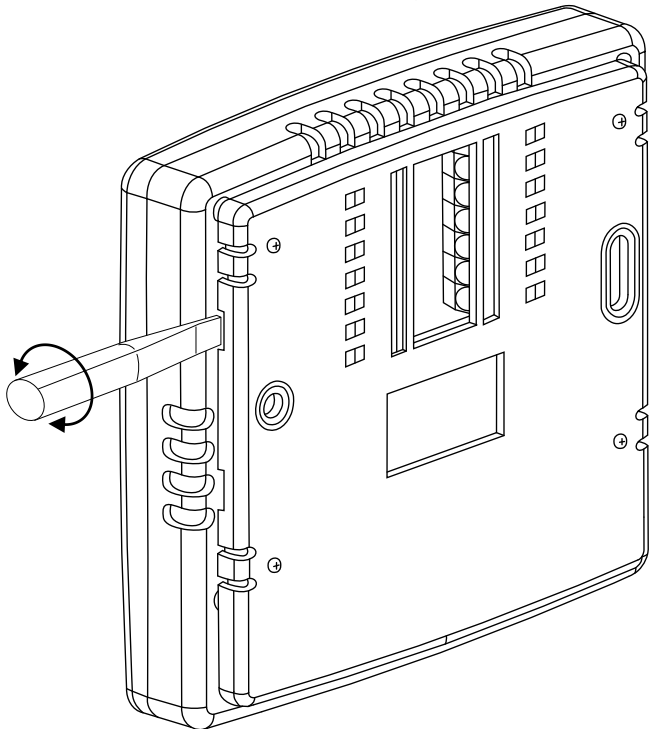

INSTALL TWO AA BATTERIES

The batteries power the clock when 24VAC power is lost. Slide the battery cover downward and install the two AA batteries as shown.

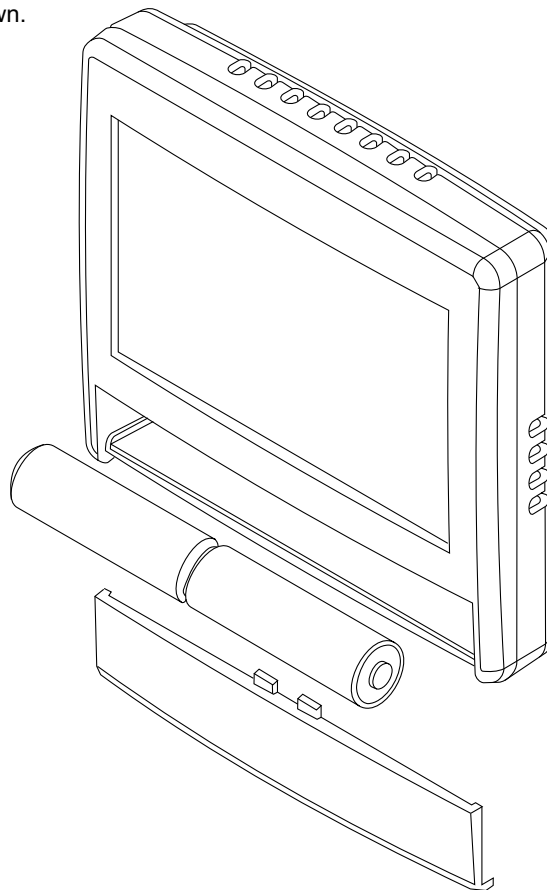

ATTACH THE SUBBASE TO THE WALL

Attach the subbase to an interior wall and about 5-feet above the floor as shown using the screws and wall anchors supplied. The wires to the dampers, HVAC equipment and the upstairs temperature sensor pass through the opening between the terminals.

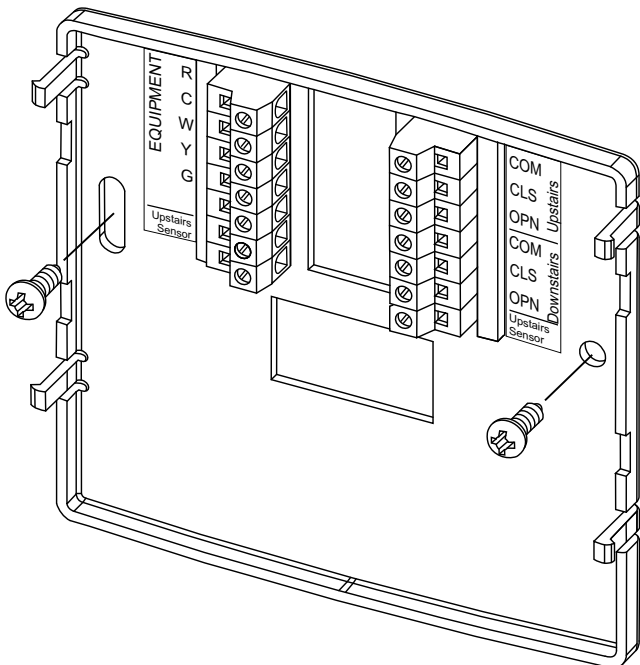

INSTALL UPSTAIRS & DOWNSTAIRS DAMPERS

Install an R80CT damper in the duct supplying air to the upstairs and wire the terminals to the corresponding terminals on the C365T. Install a second R80CT damper in the duct supplying air to the downstairs and wire it to the C365T. Each damper uses 2.4VA of power.

When two or more dampers are required to define the upstairs or downstairs zones, the damper may be wired in parallel. LEDs on the damper actuator indicate when the damper is fully open (green) or fully closed (red).

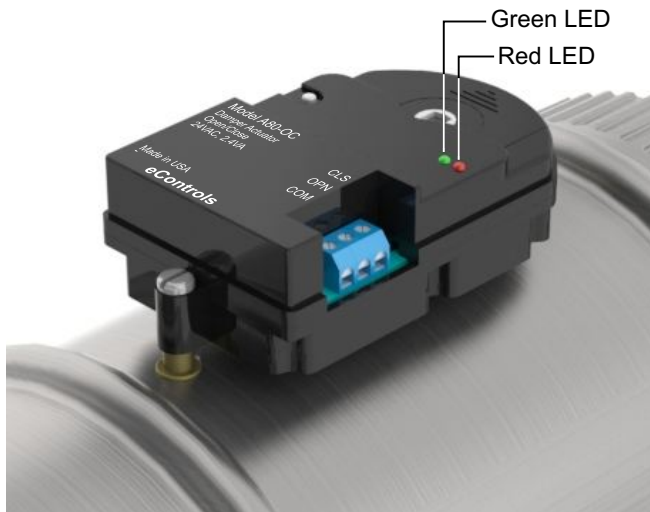

WIRING DIAGRAM

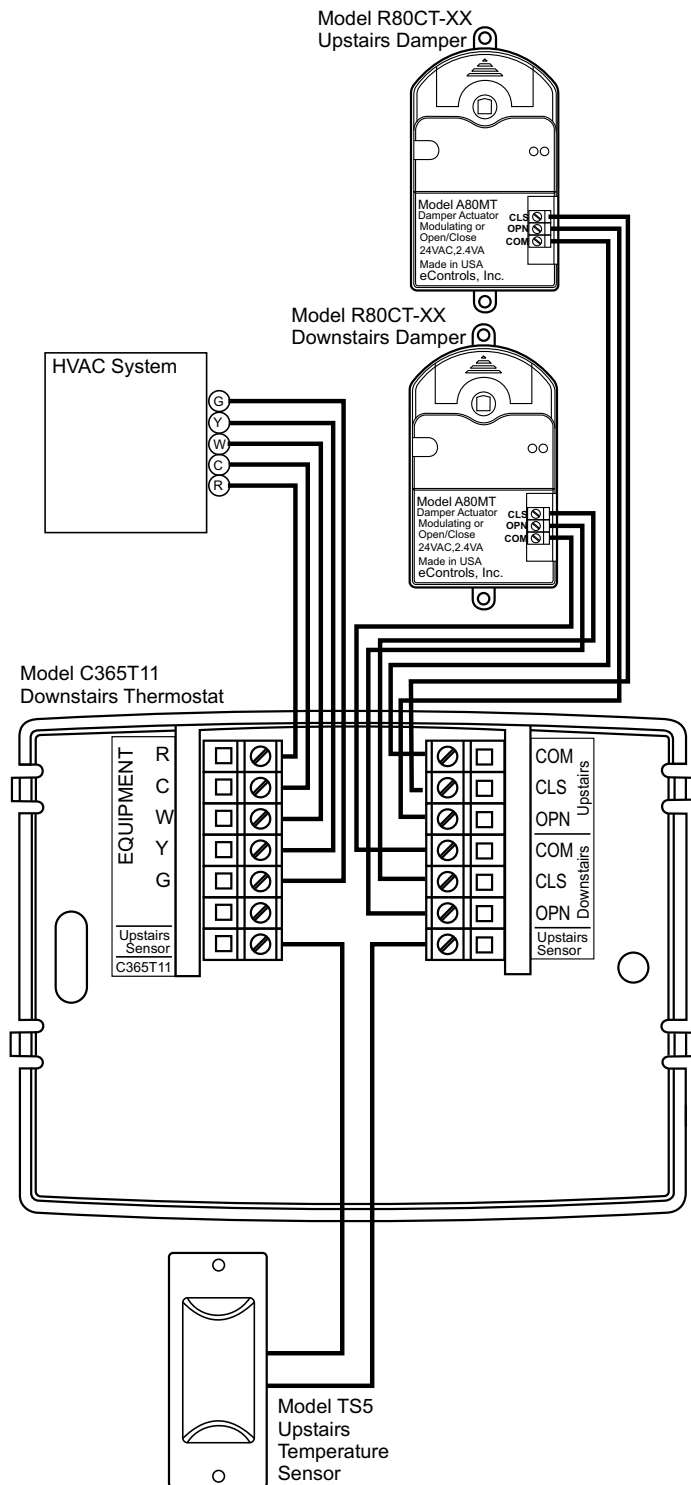

WIRING INSTRUCTIONS

Warning!

Turn the power to the HVAC equipment off before wiring.

Equipment Wiring

Use 5-conductor, 18 or 20 gage, thermostat cable to wire from the C365 Thermostat to the equipment.

C365 Terminal	Wire Color	Equipment Terminal	Function
R	Red	R, Rc, Rh	24VAC Power
C	Blue	C	Common
W	White	W, W1	Heating
Y	Yellow	Y, Y1	Cooling
G	Green	G	Fan

Damper Wiring

Use 3-conductor, 18 or 20 gage, thermostat cable to wire from the C365 Thermostat to the upstairs and downstairs dampers. There are separate terminals for the upstairs and the downstairs dampers.

C365 Terminal	Wire Color	Damper Terminal	Function
COM	White	COM	Common
CLS	Red	CLS	Closes damper
OPN	Green	OPN	Opens damper

Multiple dampers can be used to construct the upstairs or downstairs zones. Daisy chain terminals— COM to COM, OPN to OPN and CLS to CLS.

Upstairs Temperature Sensor Wiring

Use 2-conductor, 18 or 20 gage, thermostat cable to wire from the C365 Thermostat to the upstairs temperature sensor.

C365 Terminal	Wire Color	Sensor Terminal	Function
SNR	White	SNR	Thermistor
SNR	Red	SNR	Thermistor

For single temperature sensor application, use Model TS5-10.

Two temperature sensors can be installed in different areas upstairs and the two temperatures will be averaged. For dual sensor applications, use Model TS5-20 and daisy chain the sensors.

Upstairs Temperature Sensor Wiring (Cont)

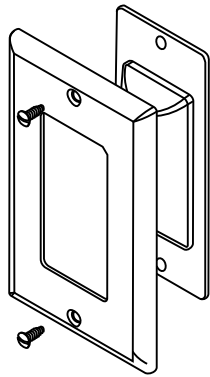
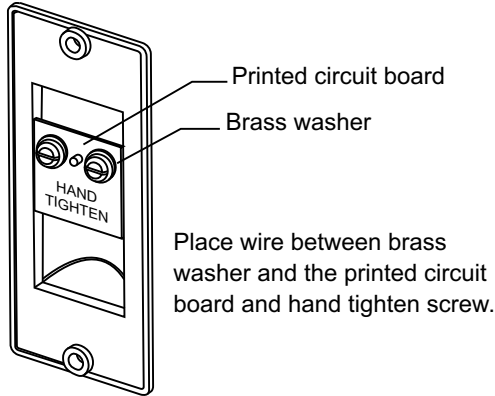

Single Upstairs Temperature Sensor

Model TS5-10
Upstairs
Temperature
Sensor

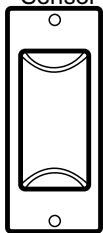

Wire to
the C365T11

Dual Upstairs Temperature Sensors

Model TS5-20 Model TS5-20
Upstairs Upstairs
Temperature Temperature
Sensor Sensor

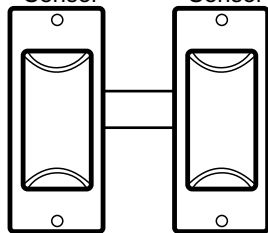

Wire to
the C365T11

i Press the touchscreen with your fingertip only, using a firm touch. Do not use a sharp object such as a pen or pencil.

Set Time and Day

Touch here to change the time and day of the week.

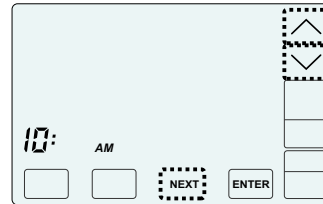
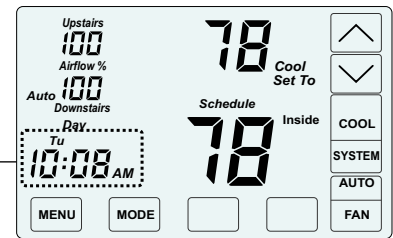

CHANGE THE HOUR

Touch the UP/DOWN keys to change the HOUR. Touch NEXT to save the hour and go to change the minute.



CHANGE THE MINUTE

Touch the UP/DOWN keys to change the MINUTE. Touch NEXT to save the minute and go to change the day of the week.

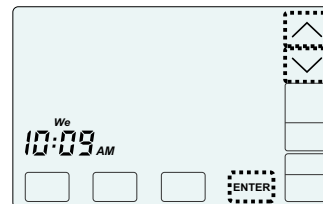

CHANGE THE DAY OF THE WEEK

Touch the UP/DOWN keys to change the DAY OF THE WEEK.

Touch ENTER to save the day for the week and return to thermostat operation.

INSTALLER OPTIONS

Option	Description	Display	Range	Default
01	Compressor Stages	Cpr	0 or 1	1
02	Heating Stages.	Htg	0 or 1	1
03	Fan Operation.	Fan	GA(Up) or EL(Down)	GA
04	Compressor Minimum Off Time (minutes).	Cot	0 to 9	2
05	Gas Minimum Off Time (minutes).	HOt	0 to 9	0
06	Minimum Run Time (minutes).	r n t	0 to 9	2
07	On-Off Temperature Differential	O O °	0, 1 or 2	1
	Differential Mode0 0.5°F On/Off span.			
	Differential Mode1 1.0°F On/Off span.			
	Differential Mode2 1.5°F On/Off span.			
08	Smart Recovery.	S r	On(Up) or Off(Down)	Off
09	Vacant Heating Setpoint.	V A C + Heat	44 to 75	65
10	Vacant Cooling Setpoint.	V A C + Cool	74 to 95	80
11	Calibrate Downstairs Sensor	C A L	+/- 5	0
12	Calibrate Upstairs Sensor.	C A L	+/- 5	0
13	Airflow Update Time	A F t	1 to 20 minutes	2
14	Night Level LCD Backlight	BL + Night	On(Up) or Off(Down)	On
15	Airflow Control On or Off	AFC	On(Up) or Off(Down)	On
16	Enable Selecting Manual Airflow Control.	UFC	On(Up) or Off(Down)	Off
17	Maximum Upstairs Airflow in Heating.	HAF+Heat	100 to 160%	150%
18	Maximum Upstairs Airflow in Cooling.	CAF+Cool	100 to 160%	140%
19	Maximum Downstairs Airflow in Heating.	HAF+Heat	100 to 160%	150%
20	Maximum Downstairs Airflow in Cooling.	CAF+Cool	100 to 160%	140%
21	Maximum Temperature Difference Between Upstairs and Downstairs.	diF	0 to 10	2
22	Factory Restore	Fr	No(Next) or Yes(Enter)	NA

ACCESSING INSTALLER OPTIONS

To access the Installer Options, **TOUCH** and **HOLD** the hidden Enter key for 7 seconds until the first Option appears on the screen.

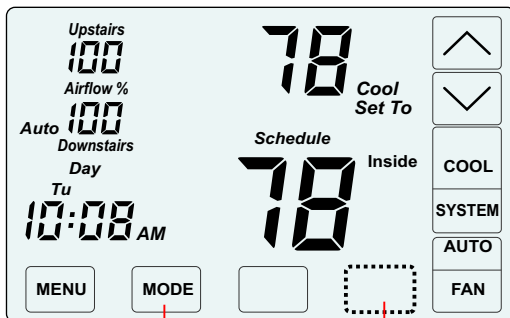

TOUCH and **HOLD** this key for 7 seconds to access the Installer Options.

The hidden BACK key can be used to return to previous options.

01 Setting the Compressor Stages

Factory Default: 1 Stage. Range: 0 or 1

This option is used to set the number of cooling stages.

Touch the **UP/DOWN** keys to set 0 or 1 stage.

Touch **NEXT** to display the next option. After about 20 seconds, the installer options will time out and return to normal thermostat operation.

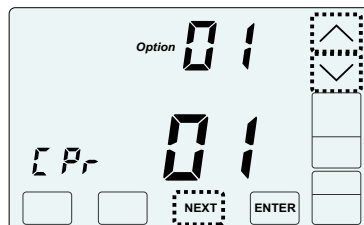

02 Setting the Heating Stages

Factory Default: 1 Stage. Range: 0 or 1

This option is used to set the number of heating stages.

Touch the **UP/DOWN** keys to set 0 or 1 stage.

Touch **NEXT** to display the next option, or **ENTER** to save the option and return to normal thermostat operation, or touch the hidden **BACK** key to return to the previous option.

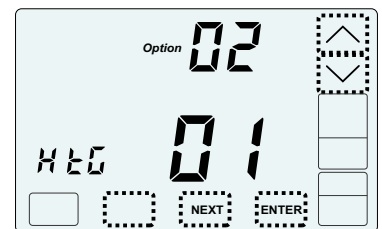

03 Setting the Fan Operation in Heating

Factory Default: Gas. Range: GA or EL

Touch the **UP** key to select "EL" for electric operation where the thermostat activates the indoor fan (G terminal) during heating calls or **DOWN** key to select GA for gas operation where the equipment plenum sensor activates the indoor fan in heating calls.

Touch **NEXT** to display the next option, or **ENTER** to save the option and return to normal thermostat operation.

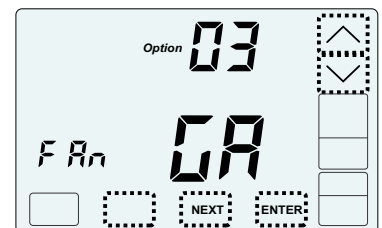

04 Compressor Minimum Off Time

Factory Default: 2 Minutes. Range: 0 to 9 Minutes

Touch the **UP/DOWN** keys to change the minimum off time (minutes) before restarting the compressor.

Touch **NEXT** to display the next option, or **ENTER** to save the option and return to normal thermostat operation.

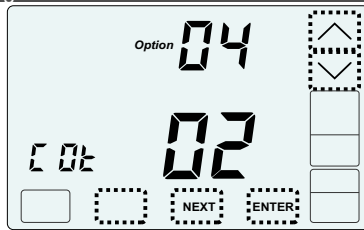

05 Heating Minimum Off Time

Factory Default: 0 Minutes. Range: 0 to 9 Minutes

Touch the **UP/DOWN** keys to change the minimum off time (minutes) before restarting a gas furnace or electric strip heater.

Touch **NEXT** to display the next option, or **ENTER** to save the option and return to normal thermostat operation.

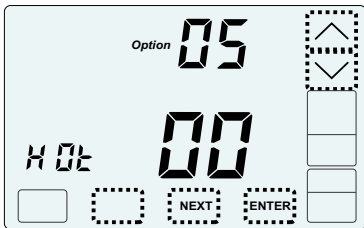

06 Minimum Run Time

Factory Default: 2 Minutes. Range: 0 to 9 Minutes

Touch the **UP/DOWN** keys to change the minimum run time (minutes) before turning a system off.

Touch **NEXT** to display the next option, or **ENTER** to save the option and return to normal thermostat operation.

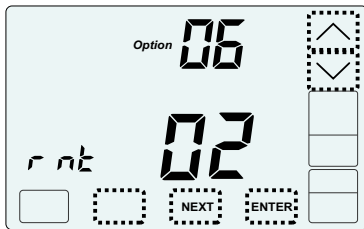

07 Setting On-Off Temp Differential

Factory Default: #1. Range: 0, 1 or 2.

Touch the **UP/DOWN** keys to select 0, 1, 2.

Touch **NEXT** to display the next option, or **ENTER** to save the option and return to normal thermostat operation, or touch the hidden **BACK** key to return to the previous option.

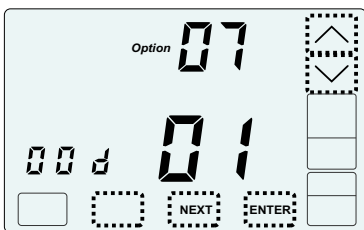

- | | |
|--------------------|--------------------|
| Differential Mode0 | 0.5°F On/Off span. |
| Differential Mode1 | 1.0°F On/Off span. |
| Differential Mode2 | 1.5°F On/Off span. |

08 Smart Recovery

Factory Default: Off. Range: On or Off.

Smart recovery initiates a heating or cooling call so that the space is at temperature when the setback period ends.

Touch the **UP** key to select ON to turn on smart recovery or touch the **DOWN** key to select OF to turn smart recovery off.

Touch **NEXT** to display the next option, or **ENTER** to save the option and return to normal thermostat operation.

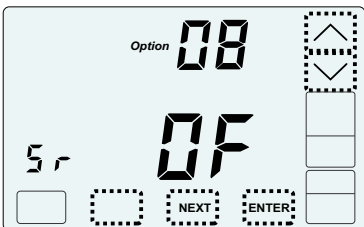

09 Vacant Heating Setpoint

Factory Default: 65°F. Range: 44°F to 75°F

Touch the **UP/DOWN** keys to select the heating temperature when the space is vacant.

Touch **NEXT** to display the next option, or **ENTER** to save the option and return to normal thermostat operation, or touch the hidden **BACK** key to return to the previous option.

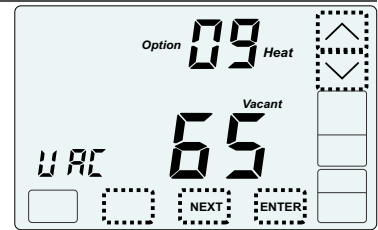

10 Vacant Cooling Setpoint

Factory Default: 80°F. Range: 74°F to 95°F

Touch the **UP/DOWN** keys to select the cooling temperature when the space is vacant.

Touch **NEXT** to display the next option, or **ENTER** to save the option and return to normal thermostat operation, or touch the hidden **BACK** key to return to the previous option.

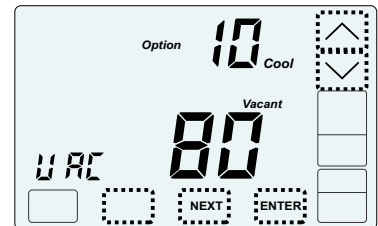

11 Calibrate Downstairs Temperature Sensor

Factory Default: None. Range - +/5°

Touch the **UP/DOWN** keys to change the downstairs (Inside) temperature to the temperature that the user feels is correct.

Touch **NEXT** to display the next option, or **ENTER** to save the option and return to normal thermostat operation, or touch the hidden **BACK** key to return to the previous option.

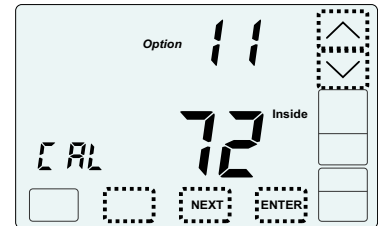

12 Calibrate Upstairs Temperature Sensor

Factory Default: None. Range - +/5°

Touch the **UP/DOWN** keys to change the upstairs (Inside2) temperature to the temperature that the user feels is correct.

Touch **NEXT** to display the next option, or **ENTER** to save the option and return to normal thermostat operation, or touch the hidden **BACK** key to return to the previous option.

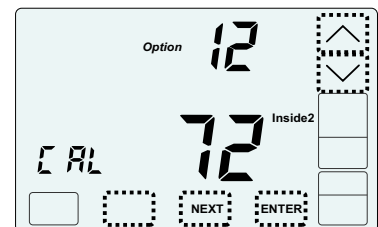

13 Airflow Update Time

Factory Default: 2 Minutes. Range: 1 to 20 Minutes.

This is the frequency, in minutes, that the damper position is updated.

Touch the **UP/DOWN** keys to set the time in minutes to update the upstairs and downstairs airflow.

Touch **NEXT** to display the next option, or **ENTER** to save the option and return to normal thermostat operation, or touch the hidden **BACK** key to return to the previous option.

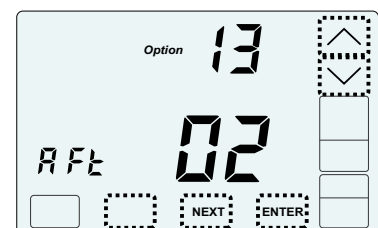

14 Night Level LCD Backlight

Factory Default: On. Range: On or Off.

The LCD has a low level backlight that can be used as a night light.

Touch the **UP** key to turn the low level backlight ON or touch the **DOWN** key to turn OFF.

Touch **NEXT** to display the next option, or **ENTER** to save the option and return to normal thermostat operation, or touch the hidden **BACK** key to return to the previous option.

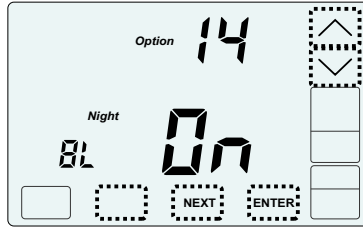

15 Airflow Control, On or Off

Factory Default: On. Range: On or Off.

This option turns the automatic airflow control on or off. If on, the thermostat will automatically adjust the airflow. If off, airflow is disabled.

Touch the **UP** key to select ON for airflow control or touch the **DOWN** key to select OFF to disable airflow control.

Touch **NEXT** to display the next option, or **ENTER** to save the option and return to normal thermostat operation, or touch the hidden **BACK** key to return to the previous option.

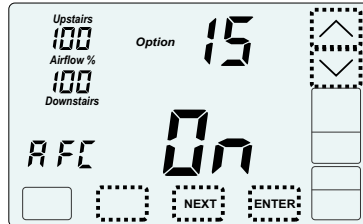

16 Enable Selecting Manual Airflow Control

Factory Default: Off. Range: On or Off.

This option enables the user to select automatic or manual airflow. In automatic, the thermostat controls the airflow. Automatic is the default. In manual, the user must adjust the airflow.

Touch the **UP** key to select ON to enable manual airflow control or touch the **DOWN** key to select Off so that manual airflow control is not an option.

Touch **NEXT** to display the next option, or **ENTER** to save the option and return to normal thermostat operation, or touch the hidden **BACK** key to return to the previous option.

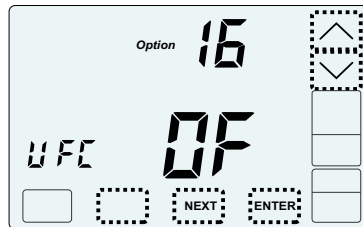

For options 17 - 20, use the installer test on pages 7-8 to determine the maximum allowable airflow.

17 Maximum Upstairs Airflow in Heating

Factory Default: 150%. Range: 100% to 160%.

Touch the **UP/DOWN** keys to select the maximum allowable upstairs airflow in heating.

Touch **NEXT** to display the next option, or **ENTER** to save the option and return to normal thermostat operation, or touch the hidden **BACK** key to return to the previous option.

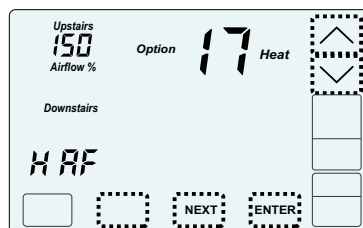

18 Maximum Upstairs Airflow in Cooling

Factory Default: 140%. Range: 100% to 160%.

Touch the **UP/DOWN** keys to select the maximum allowable upstairs airflow in cooling.

Touch **NEXT** to display the next option, or **ENTER** to save the option and return to normal thermostat operation, or touch the hidden **BACK** key to return to the previous option.

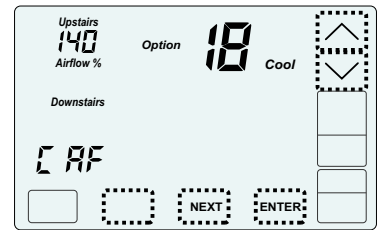

19 Maximum Downstairs Airflow in Heating

Factory Default: 150%. Range: 100% to 160%.

Touch the **UP/DOWN** keys to select the maximum allowable downstairs airflow in heating.

Touch **NEXT** to display the next option, or **ENTER** to save the option and return to normal thermostat operation, or touch the hidden **BACK** key to return to the previous option.

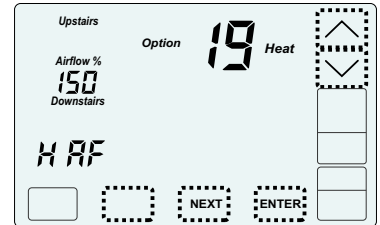

20 Maximum Downstairs Airflow in Cooling

Factory Default: 140%. Range: 100% to 160%.

Touch the **UP/DOWN** keys to select the maximum allowable downstairs airflow in cooling.

Touch **NEXT** to display the next option, or **ENTER** to save the option and return to normal thermostat operation, or touch the hidden **BACK** key to return to the previous option.

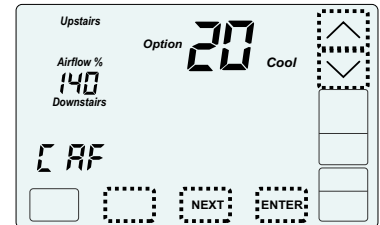

21 Maximum Temperature Differential

Factory Default: 2°F. Range: 0° to 10° F

This is the maximum allowable temperature difference between the upstairs and downstairs temperatures. When the temperature difference is equal to or greater than the allowed differential, the airflow is adjusted.

Touch the **UP/DOWN** keys to select the maximum allowable temperature difference between the upstairs and downstairs.

Touch **NEXT** to display the next option, or **ENTER** to save the option and return to normal thermostat operation, or touch the hidden **BACK** key to return to the previous option.

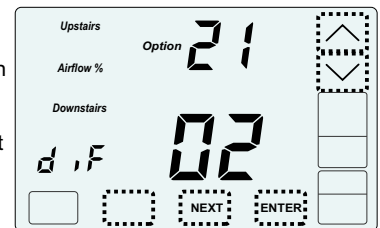

22 Factory Restore

WARNING! Factory Restore resets ALL settings.

Touch **NEXT** or **ENTER** to return to normal thermostat operation. Touch the hidden **BACK** key to return to previous option.

To restore factory settings, touch **ENTER**, then touch the **UP** key.

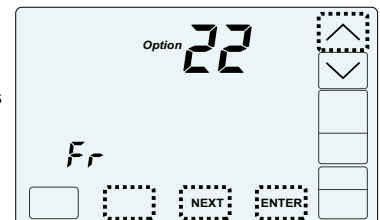

ACCESSING THE TEST MENU

The Test Menu is used to test the Indoor Fan Operation, Allowable Heating Airflow Limits and Allowable Cooling Airflow Limits.

The Test Menu can also be used to perform the HERS Total Airflow test. Option 05-06 activates a cooling call and opens both dampers to 100% enabling the installer to perform the test.

To access the Test Menu, **TOUCH** and **HOLD** the hidden Next key for 7 seconds until the fan test screen (Option 01) appears.

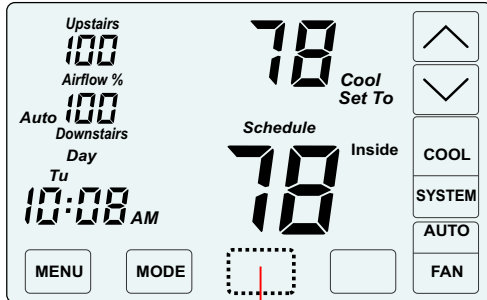

TOUCH and **HOLD** this key for 7 seconds to access the Installer Options.

01-02 Testing Indoor Fan Operation

This test is used to verify that the indoor fan is operating correctly.

In Option 1, the Fan is Off.

Touch **NEXT** to go to Option 2 to turn on the indoor fan. Verify the fan is operating and delivering airflow to the upstairs and downstairs..

Touch **NEXT** to go Testing Heating Airflow Limits.

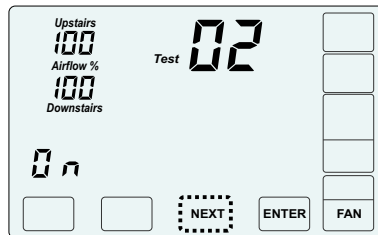
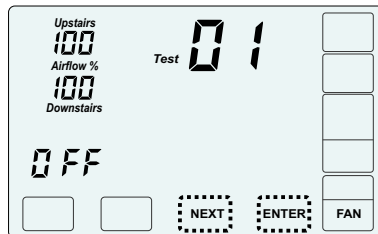

03-04 Testing Heating Airflow Limits

This test is used to determine the maximum allowable upstairs airflow and the maximum allowable downstairs airflow in HEATING.

In Option 3, the system is Off.

Touch **NEXT** to go to Option 4 to activate heating. Verify the equipment is operating.

To determine the maximum allowable upstairs airflow, touch the **UP** key until the airflow is too great and causes noise or annoyance. Lower the airflow using the **DOWN** key until it is acceptable. This is the maximum allowable upstairs airflow in heating. Record the airflow value.

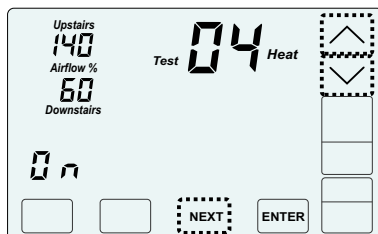
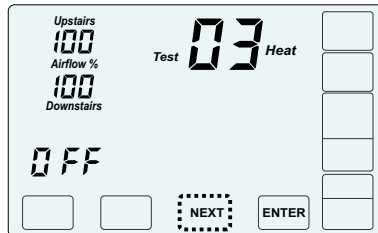

Maximum Allowable Upstairs Airflow in Heating

03-04 Testing Heating Airflow Limits (cont.)

To determine the maximum allowable downstairs airflow, touch the **DOWN** key until the airflow is too great and causes noise or annoyance. Increase the airflow using the **UP** key until it is acceptable. This is the maximum allowable downstairs airflow in heating. Record the airflow value.

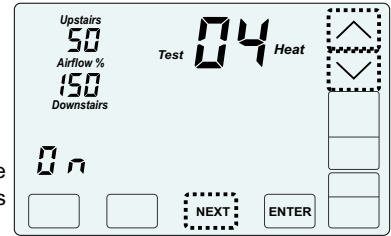

Maximum Allowable Downstairs Airflow in Heating

Touch **NEXT** to go to Testing Cooling Airflow Limits.

05-06 Testing Cooling Airflow Limits

This test is used to determine the maximum allowable upstairs airflow and maximum allowable downstairs airflow in COOLING.

The test can also be used to perform the HERS Total Airflow test. The test activates a cooling call and opens both dampers to 100%.

In Option 5, the system is Off.

Touch **NEXT** to go to Option 6 to activate cooling. Verify the equipment is operating.

To determine the maximum allowable upstairs airflow, touch the **UP** key until the airflow is too great and causes noise or annoyance. Lower the airflow using the **DOWN** key until it is acceptable. This is the maximum allowable upstairs airflow in cooling. Record the airflow value.

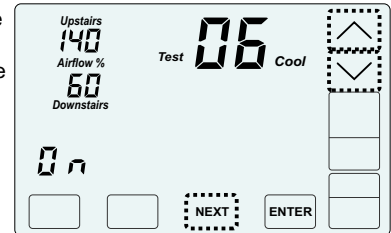
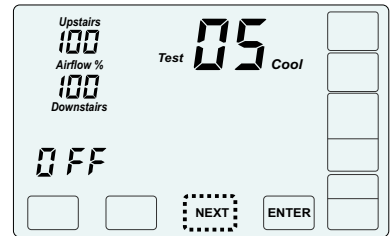

Maximum Allowable Upstairs Airflow in Cooling

To determine the maximum allowable downstairs airflow, touch the **DOWN** key until the airflow is too great and causes noise or annoyance. Increase the airflow using the **UP** key until it is acceptable. This is the maximum allowable downstairs airflow in cooling. Record the airflow value.

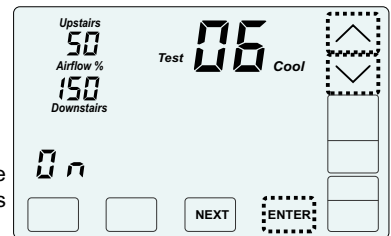

Maximum Allowable Downstairs Airflow in cooling

Touch **ENTER** to end testing and return to normal thermostat operation.

Enter the maximum airflow limits using Options 17 through 20 of the installer menu.